

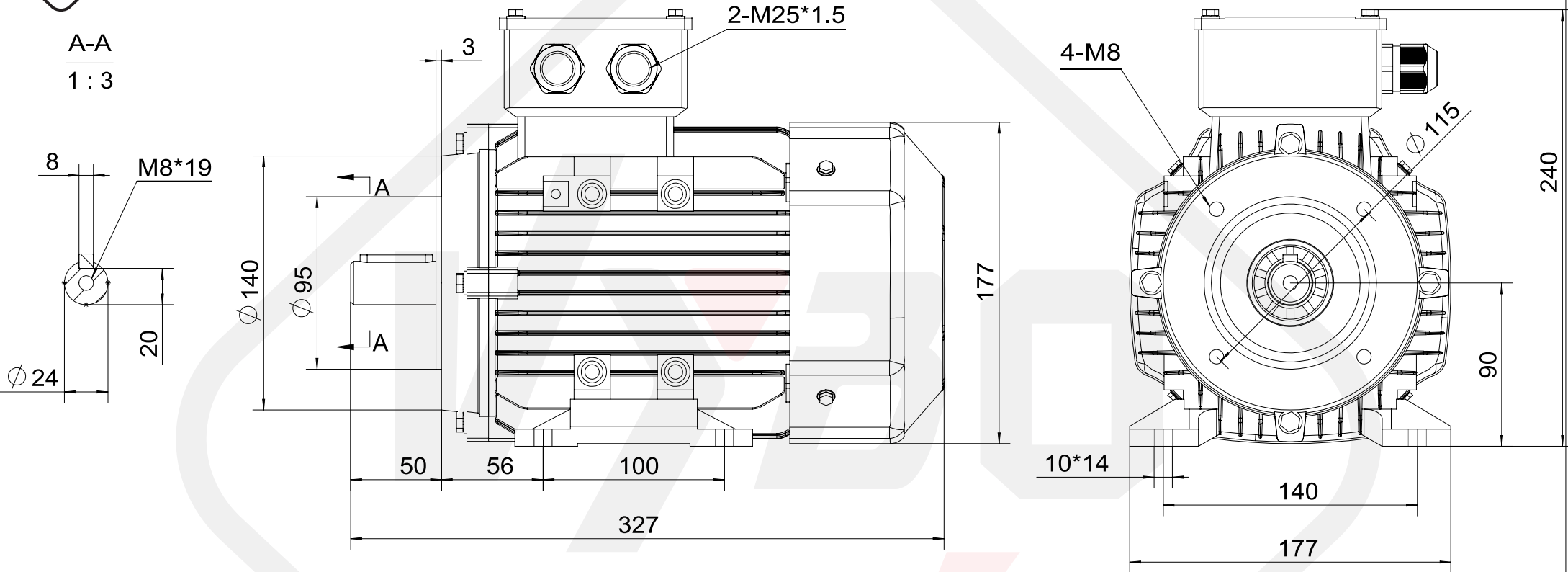

A-A
1:3



Electric s.r.o.

2AL-90S-B34
Mounting diagram